

Lecture 4: Integer Programming (IP)

- Fractional solutions vs. integer solutions
- Upper/lower bounds on the optimal
- Fractional feasible set vs. integer feasible set
- Decision variables
- Shortest path revisited: decision variables

Optimum Z^* of a LP

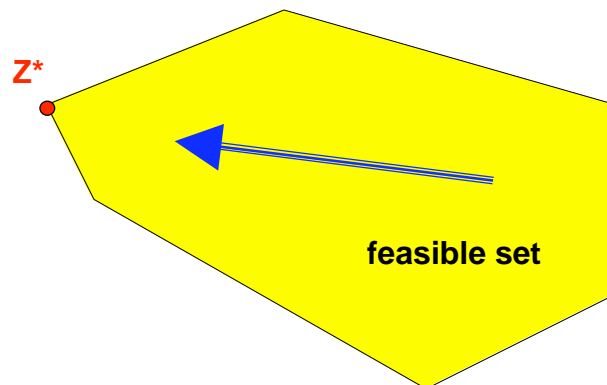

What if the desired solution is not an integer?

What if this represents the number of trucks and drivers?

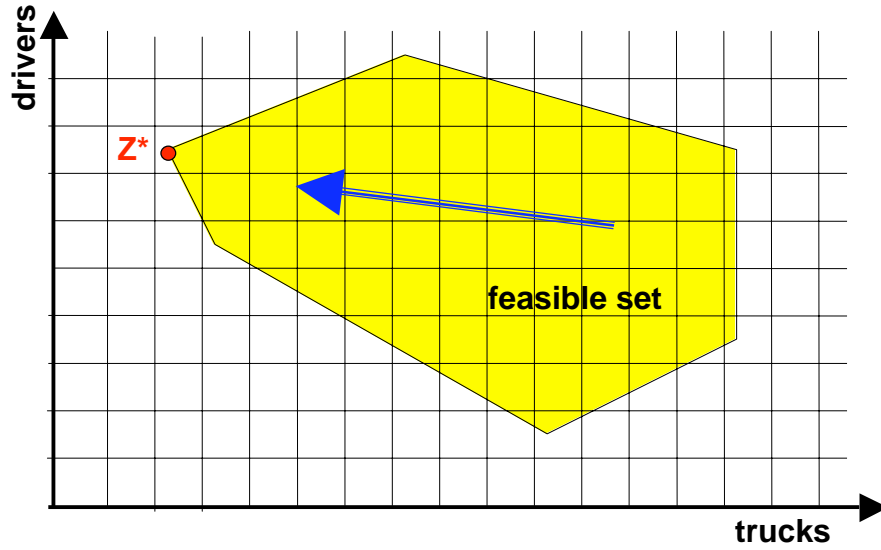

Fractional solution

What if this represents the number of trucks and drivers?

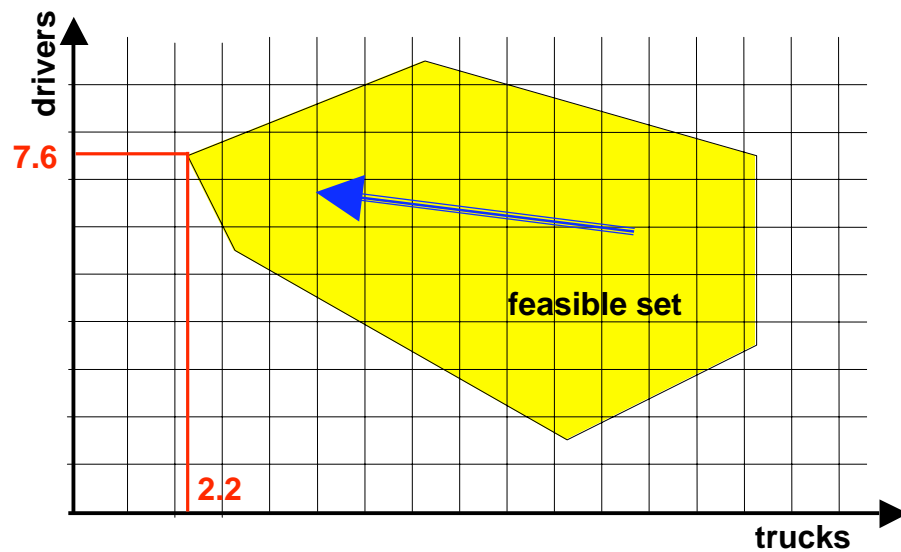

Fractional solution

What should one do?

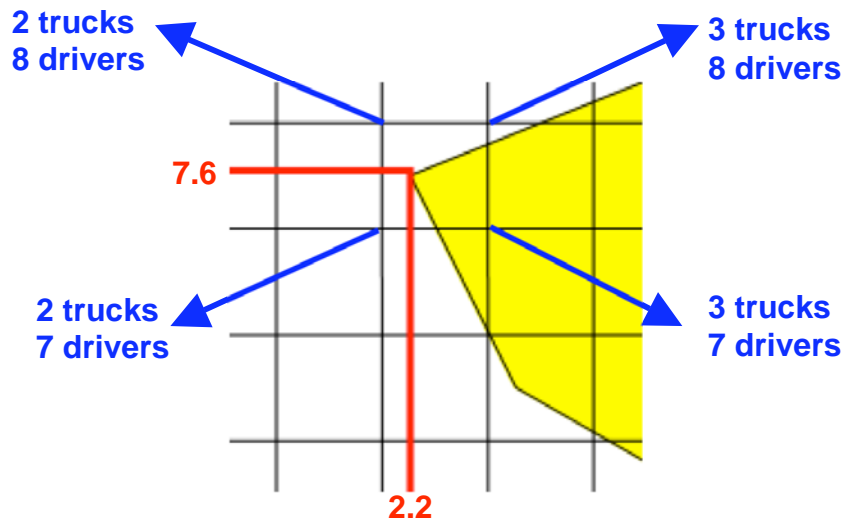

Fractional solution

What should one do?

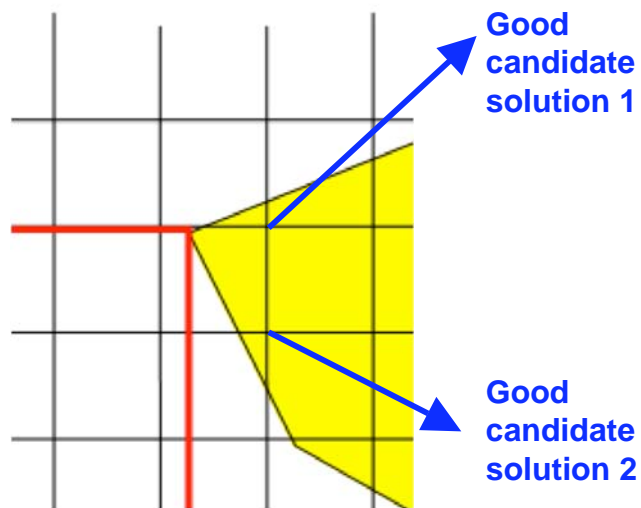

Upper or lower bound on the optimal

The fractional solution gives you an upper bound or a lower bound on the optimal.

- If this is a minimization problem, it gives you a lower bound on the optimal
- If this is a maximization problem, it gives you an upper bound on the optimal

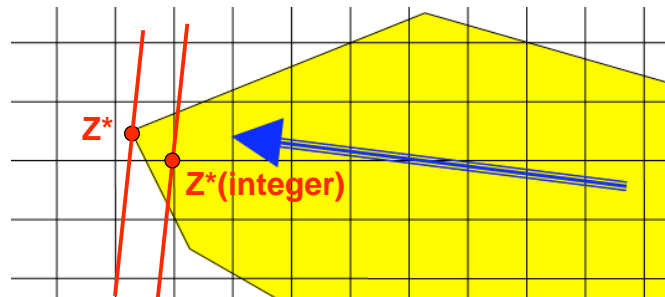

Upper or lower bound on the optimal

The fractional solution gives you an upper bound or a lower bound on the optimal.

Integer problems are sometimes **very hard** to solve exactly. But maybe your boss would prefer a guaranteed upper bound on the cost (**quick and dirty, but correct**)

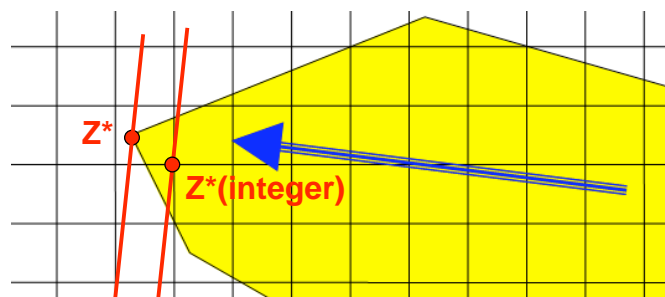

Problems of fractional vs. integer solution

The feasible set for fractional solutions is larger

- The result is better
 - If this is a maximization problem, it is larger
 - If it is a minimization problem it is smaller
- The result might not be physical
 - Cut the driver in two and the truck in three
- Is there a way to find A / THE optimal integer solution from the fractional solution?
This is a hard problem!!!

Optimum, value of the optimal solution

Does an integer solution to the problem exist?

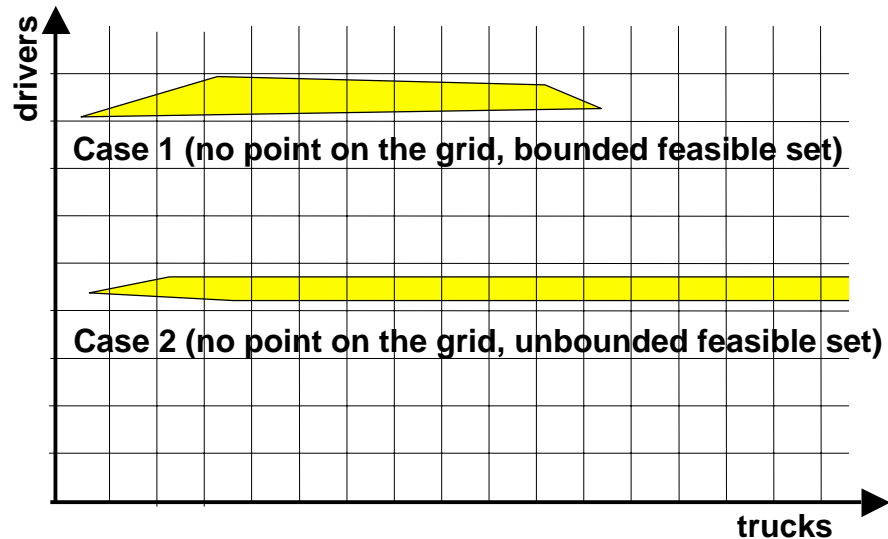

Decision variables

A possible definition for a decision variable is a variable that corresponds to a « yes/no » problem, i.e. that corresponds to a discrete choice.

Decision variables can be modeled by integer variables

→ Example 1: do I hire this worker ($d=1$) or not ($d=0$)

→ Example 2: how many cars are allowed in this parking lot everyday: $n=0,1,2,3,4,5,6$,

→ Example 3: do I take

- the first train ($d=1$)
- the second train ($d=2$)
- the fifth train ($d=5$)

→ Example 4: at this intersection, do I take

- the first left
- the second left
- the first right

Shortest path revisited: decision variables

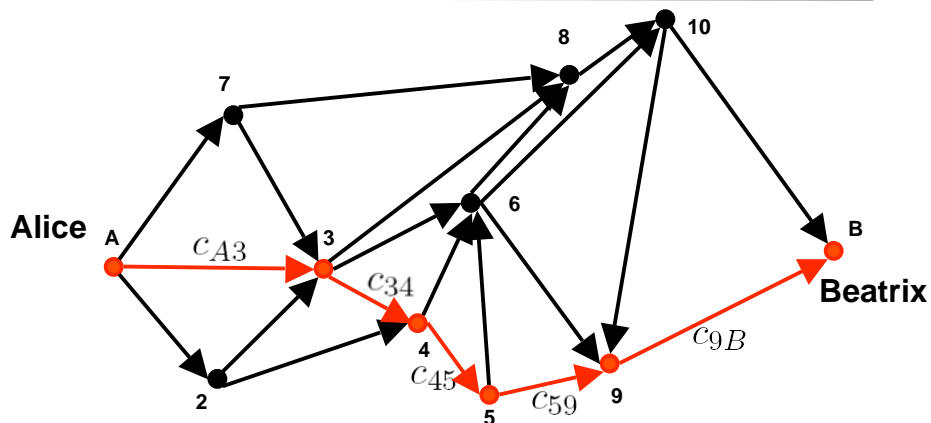

Shortest path revisited: decision variables

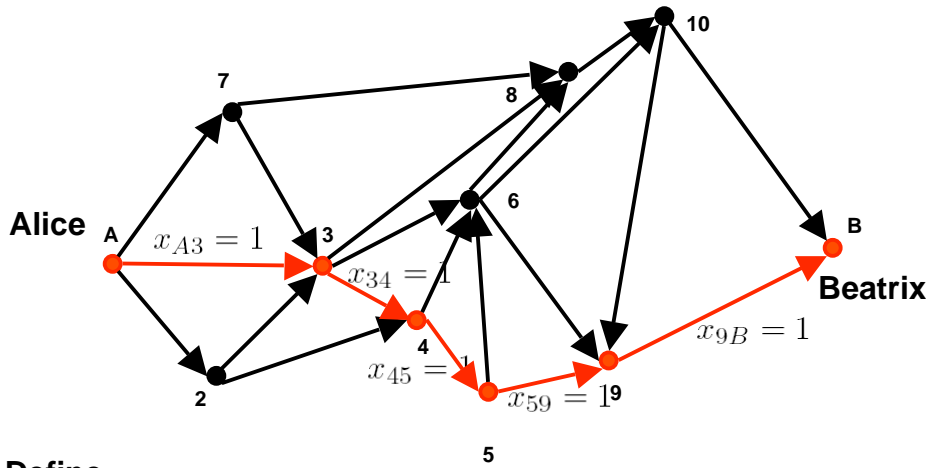

Define

- $x_{ij} = 1$ For every (i,j) on the shortest path
- $x_{ij} = 0$ For every (i,j) not on the shortest path

Shortest path revisited: decision variables

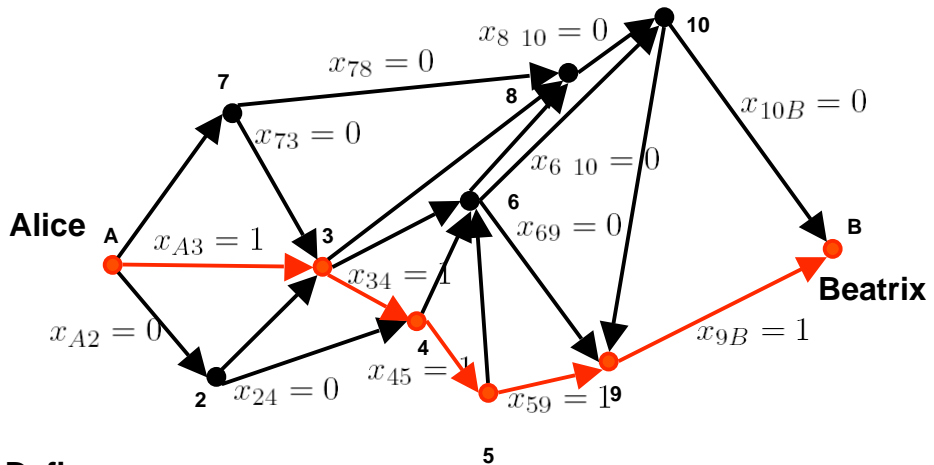

Define

- $x_{ij} = 1$ For every (i,j) on the shortest path
- $x_{ij} = 0$ For every (i,j) not on the shortest path

Shortest path revisited: decision variables

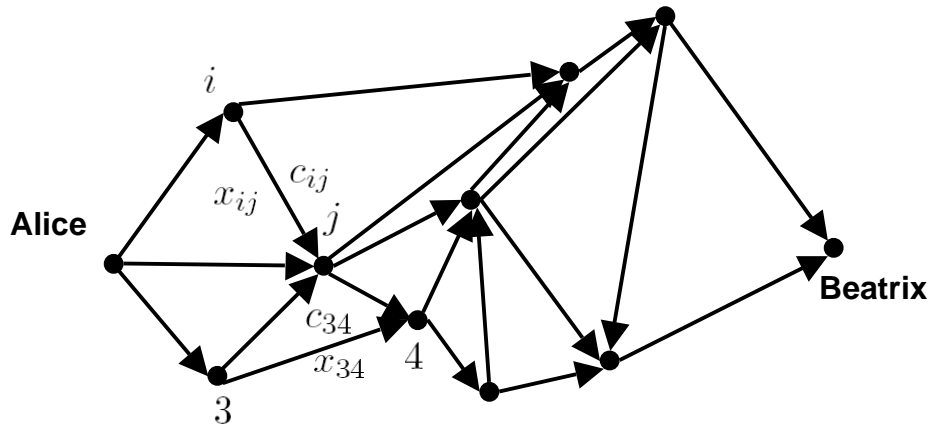

Define

- $x_{ij} = 1$ For every (i,j) on the shortest path
- $x_{ij} = 0$ For every (i,j) not on the shortest path

Shortest path revisited: decision variables

Define a graph (road network)

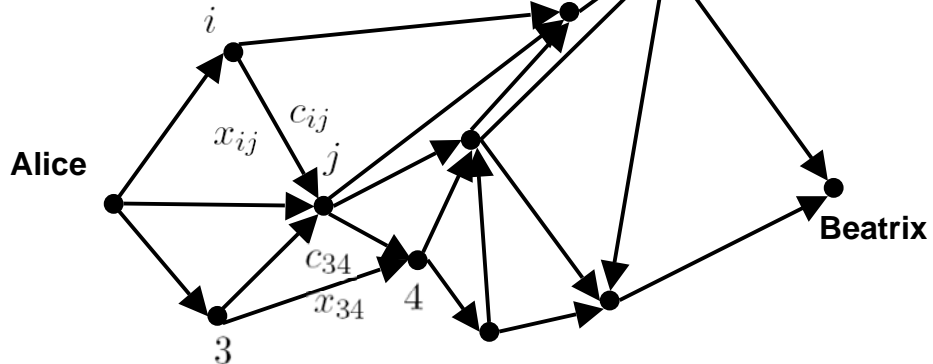

Take $x_{ij} = 1$ if Eva decides to go through link (i,j), zero otherwise

For example $x_{34} = 1$ if Eva decides to use route (3,4)

Shortest path revisited: decision variables

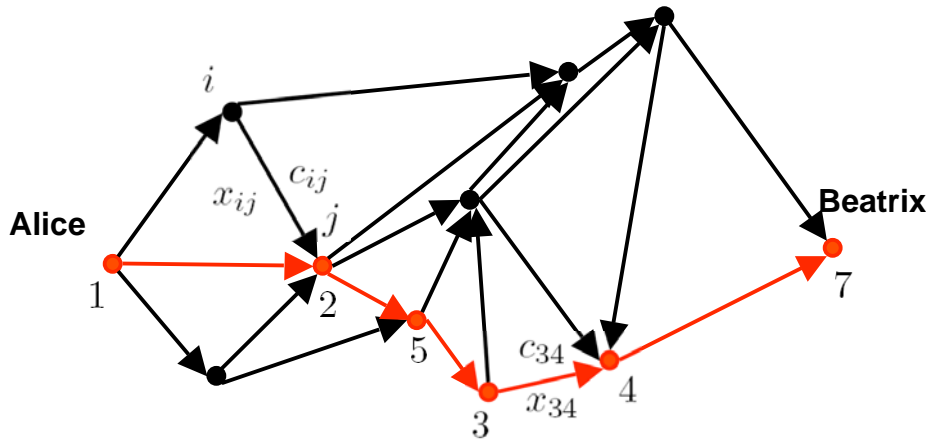

$$x_{12} = x_{25} = x_{53} = x_{34} = x_{47} = 1$$

All other x_{ij} are zero

Total length of this path: $c_{12} + c_{25} + c_{53} + c_{34} + c_{47}$

Shortest path revisited: decision variables

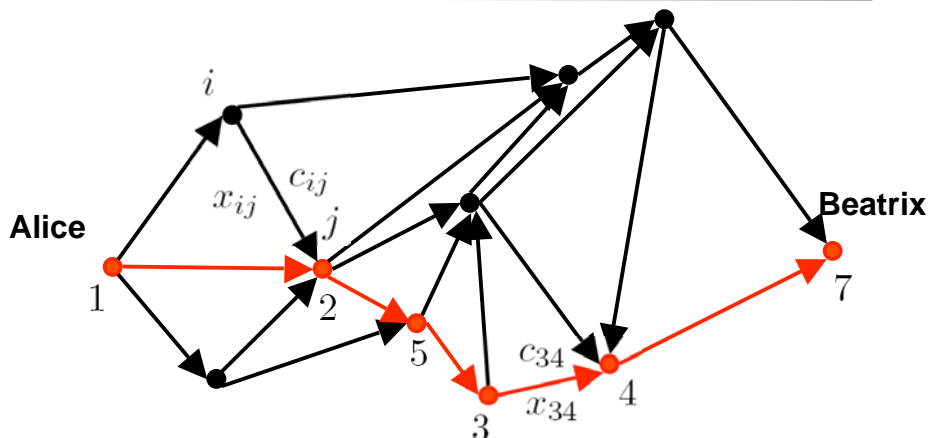

$$x_{12} = x_{25} = x_{53} = x_{34} = x_{47} = 1 \quad \text{All other } x_{ij} \text{ are zero}$$

Decision variables x_{ij} cannot be fractional, i.e. 0.534.

How do we ensure that the program solving the LP provides an integer solution?

Shortest path revisited: decision variables

$$\text{minimize: } Z = \sum_{j \in N_A} c_{Aj} x_{Aj} + \sum_{i=1}^{10} \sum_{j \in N_i} c_{ij} x_{ij} + \sum_{j \in N_B} c_{jB} x_{jB}$$

$$\text{such that: } \sum_{j \in N_i} x_{ji} = \sum_{j \in N_i} x_{ij}, \quad i = 1, \dots, 10$$

$$\sum_{j \in N_A} x_{Aj} = 1$$

$$\sum_{j \in N_B} x_{jB} = 1$$

$$x_{ij} \geq 0, \quad x_{jB} \geq 0, \quad x_{Aj} \geq 0$$

In other words, if we put this in MATLAB to solve the shortest path problem, how do we know that MATLAB will return integer decision variables?